

Electrical Connection

Pre-Wired

Cable: PVC 5 x 0,75 mm²

Length: 1 m.

(Different cables or lengths, page 13)



Operating Head Type

G11 - Plain plunger

G1• - Roller plunger

G12: metal roller
G13: nylon roller

G1• - Cross roller plunger

G14: metal roller
G15: nylon roller

Conformity / \rightarrow (N.C. contact with positive opening operation)
Max actuation speed [m/s]
Min. force [N] or torque [Nm]: actuation / positive opening operation

0,5
15 / 30

0,1
10 / 30

0,1
10 / 30

Additional Technical Datas

Z	Order Code	EM1G11Z	EM1G1•Z	EM1G1•Z
Snap Action Contacts (1NO + 1NC)	Operation Diagram			
X	Order Code	EM1G11X	EM1G1•X	EM1G1•X
Non overlapping Slow Action Contacts (1NO + 1NC)	Operation Diagram			

Weight (packing per unit)	[kg]	0,175	0,180	0,180
----------------------------------	-------------	--------------	--------------	--------------

Dimensions (in mm)

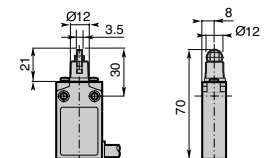
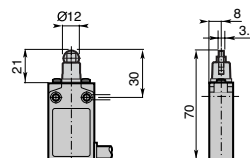
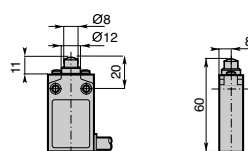
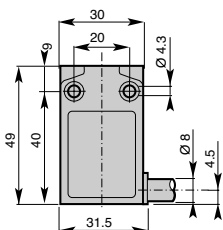



G16 - Plain plunger with dust protection cup	G21 - Plain plunger with fixing nuts	G2• - Roller plunger with fixing nuts G22: Metal roller G23: Nylon roller	G2• - Cross roller plunger with fixing nuts G24: metal roller G25: nylon roller	G4• - Ø 14 roller lever G41: nylon roller G42: metal roller G43: ball bearing
0,5 15 / 30	0,5 15 / 30	0,1 10 / 30	0,1 10 / 30	1,5 0,08 / 0,28

EM1G16Z 	EM1G21Z 	EM1G2•Z 	EM1G2•Z 	EM1G4•Z
EM1G16X 	EM1G21X 	EM1G2•X 	EM1G2•X 	EM1G4•X

0,180	0,190	0,195	0,195	0,225
--------------	--------------	--------------	--------------	--------------

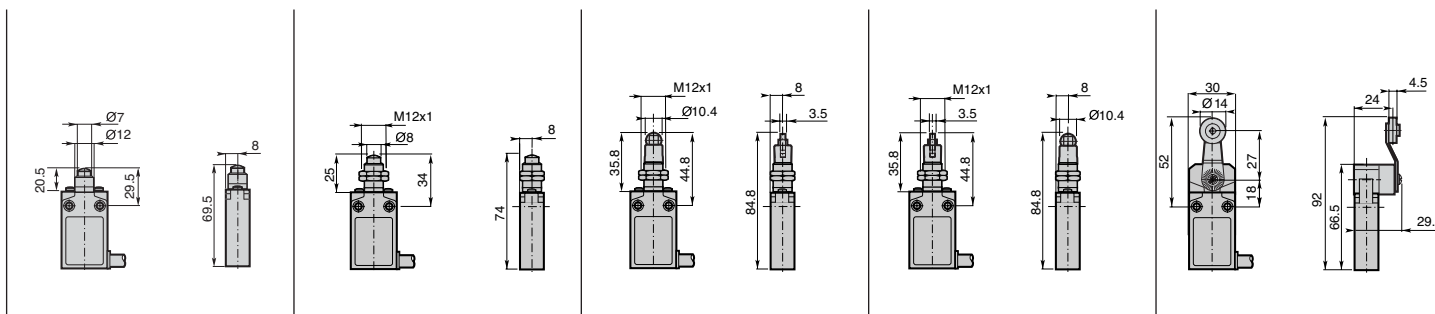

Electrical Connection

Pre-Wired

Cable: PVC 5 x 0,75 mm²

Length: 1 m.

(Different cables or lengths, page 13)



Operating Head Type

	G45 - Ø 18 nylon roller lever	G51 - Adjustable lever with Ø 18 nylon roller	G5100 - Adjustable toothed lever (step 2 mm) with Ø 18 nylon roller
Conformity /			
Max actuation speed [m/s]	1,5	1,5	1,5
Min. force [N] or torque [Nm]: actuation / positive opening operation	0,08 / 0,28	0,08 / 0,28	0,08 / 0,28

Additional Technical Datas

Z Snap Action Contacts (1NO + 1NC)	Order Code Operation Diagram	EM1G45Z	EM1G51Z	EM1G5100Z
X Non overlapping Slow Action Contacts (1NO + 1NC)	Order Code Operation Diagram	EM1G45X	EM1G51X	EM1G5100X

Weight (packing per unit)	[kg]	0,230	0,240	0,240
----------------------------------	-------------	--------------	--------------	--------------

Dimensions (in mm)

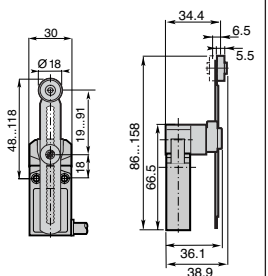
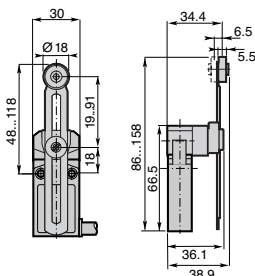
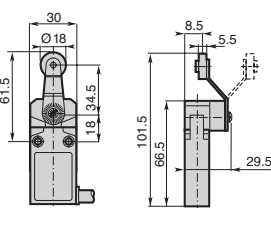
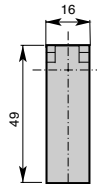
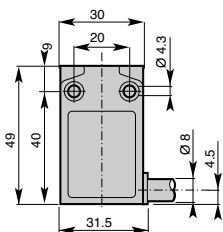



G61 - Nylon actuator with stainless steel spring	G7• - Adjustable rod lever G71: stainless steel rod Ø3 G72: fiberglass rod Ø3 G75: square steel rod 3x3	G7• - Adjustable Ø 6 rod lever G73: nylon rod G74: fiberglass rod	G92: Multidirectional nylon actuator with stainless steel spring	G93: Multidirectional actuator with stainless steel spring
1,5 0,08 / -	1,5 0,08 / 0,28	1,5 0,08 / 0,28	1,0 0,10 / -	1,0 0,10 / -

EM1G61Z 	EM1G7•Z 	EM1G7•Z 	EM1G92Z 	EM1G93Z
EM1G61X 	EM1G7•X 	EM1G7•X 		

0,240	0,235	0,250	0,245	0,250