

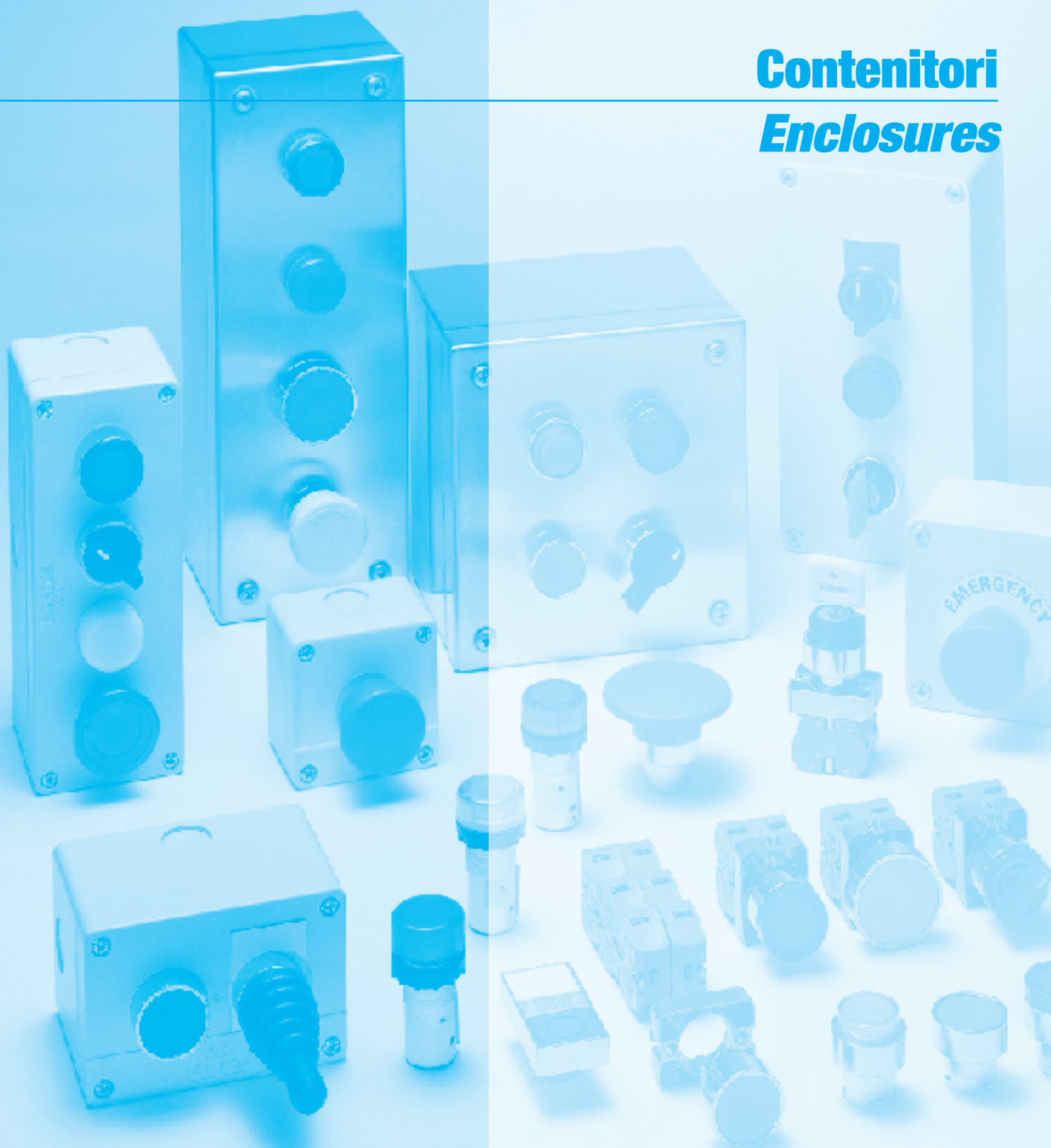

# Contenitori *Enclosures*





### Dati tecnici generali / General Technical Data

<b>Norme / Standards</b>		IEC947-5-1 / EN 60 947-5-1
<b>Temperatura ambiente/ Air temperature</b>		
– funzionamento / during operation	°C	– 25 ... + 70 °C
– stoccaggio / for storage	°C	–40 ... + 80 °C
<b>Grado di protezione</b> (secondo IEC 529 ed EN 60529) <b>Degree of protection</b> (according to IEC 529 and EN60529)		IP65 IP65
<b>Materiale</b> <b>Material</b>		Termoplastico ABS Thermoplastic ABS
<b>Colore contenitore</b> <b>Box colour</b>		Grigio RAL 7035 Gray RAL 7035
<b>Colori coperchio</b> <b>Colours of the box lid</b>		Grigio RAL 7035 / Giallo RAL 1003 Gray RAL 7035 / Yellow RAL 1003

Per cassette assemblate con pulsanti contattare il nostro ufficio commerciale / Upon request, all the enclosures can be supplied complete with our ECX pushbutton series. Please contact our commercial department

### Piastrine di messa a terra Grounding plates

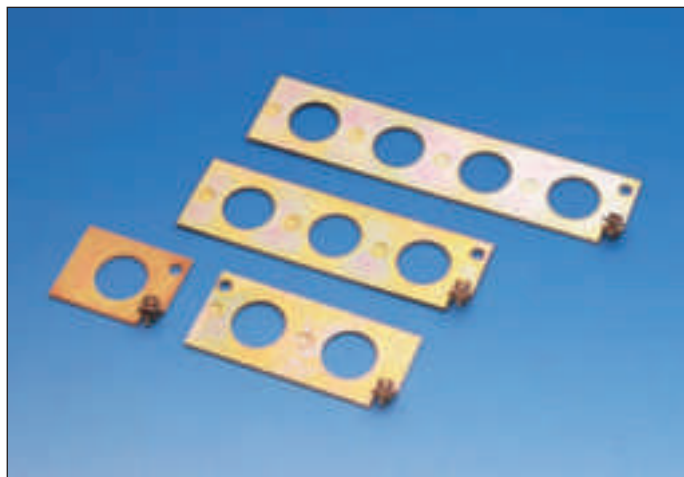

Descrizione / Description	Codice / Code
Per contenitori con 1 foro Suitable for boxes with 1 hole	<b>SA 1</b>
Per contenitori con 2 fori Suitable for boxes with 2 holes	<b>SA 2</b>
Per contenitori con 3 fori Suitable for boxes with 3 holes	<b>SA 3</b>
Per contenitori con 4 fori Suitable for boxes with 4 holes	<b>SA 4</b>
Per contenitori con 5 fori Suitable for boxes with 5 holes	<b>SA 5</b>

Contenitori senza fori  
Boxes without holes



Colore Colour	L x L mm. L x W mm.	H mm. H mm.	Codice Code
Grigio / Gray	70x70	51	<b>SA 100/00 SL</b>
Grigio / Gray	70x70	74	<b>SA 103/00 SL</b>
Grigio / Gray	105x70	51	<b>SA 105/00 SL</b>
Grigio / Gray	105x70	74	<b>SA 106/00 SL</b>
Grigio / Gray	140x70	51	<b>SA 107/00 SL</b>
Grigio / Gray	140x70	74	<b>SA 108/00 SL</b>
Grigio / Gray	185x70	51	<b>SA 109/00 SL</b>
Grigio / Gray	185x70	74	<b>SA 110/00 SL</b>
Grigio / Gray	225x70	74	<b>SA 111/00 SL</b>
Grigio / Gray	180x110	89	<b>SA 200/00 SL</b>
Grigio / Gray	180x180	116	<b>SA 300/00 SL</b>

Per le dimensioni vedi pagina 24-25 / For dimensions see page 24-25

Contenitori con 1 foro  
Boxes with 1 hole



Colore coperchio Lid colour	H mm. H mm.	Codice Code
Grigio / Gray	51	<b>SA 100 SL</b>
Giallo / Yellow	51	<b>SA 101 SL</b>
Grigio / Gray	74	<b>SA 103 SL</b>
Giallo / Yellow	74	<b>SA 104 SL</b>

Per le dimensioni vedi pagina 24-25 / For dimensions see page 24-25

Contenitori con 2 fori  
Boxes with 2 holes



Colore / Colour	H mm.	l* mm.	Codice / Code
Grigio / Gray	51	40	<b>SA 105/40 SL</b>
Giallo / Yellow	51	40	<b>SA 105/40Y SL</b>
Grigio / Gray	74	40	<b>SA 106/40 SL</b>
Giallo / Yellow	74	40	<b>SA 106/40Y SL</b>

\*l = Interasse tra i fori

\*l = distance between center of the holes

Per le dimensioni vedi pagina 24-25 / For dimensions see page 24-25

Contenitori con 3 fori  
Boxes with 3 holes



Colore / Colour	H mm.	I* mm.	Codice / Code
Grigio / Gray	51	40	<b>SA 107/40 SL</b>
Grigio / Gray	74	40	<b>SA 108/40 SL</b>

\*I = Interasse tra i fori

\*I = distance between center of the holes

Per le dimensioni vedi pagina 24-25 / For dimensions see page 24-25

Contenitori con 4 fori  
Boxes with 4 holes



Colore / Colour	H mm.	I* mm.	Codice / Code
Grigio / Gray	51	40	<b>SA 109/40 SL</b>
Grigio / Gray	74	40	<b>SA 110/40 SL</b>

\*I = Interasse tra i fori

\*I = distance between center of the holes

Per le dimensioni vedi pagina 24-25 / For dimensions see page 24-25

Contenitori con 5-6 fori  
Boxes with 5-6 holes



Colore / Colour	H mm.	N. fori / N. holes	Codice / Code
Grigio / Gray	74	5	<b>SA 111 SL</b>
Grigio / Gray	74	6	<b>SA 112 SL</b>

Per le dimensioni vedi pagina 24-25 / For dimensions see page 24-25

Contenitori con 6-7-8-9 fori  
Boxes with 6-7-8-9 holes



Colore / Colour	H mm.	I* mm.	Codice / Code
Grigio / Gray	89	6	<b>SA 206 SL</b>
Grigio / Gray	89	7	<b>SA 207 SL</b>
Grigio / Gray	89	8	<b>SA 208 SL</b>
Grigio / Gray	89	9	<b>SA 209 SL</b>

Per le dimensioni vedi pagina 24-25 / For dimensions see page 24-25

Contenitori con 9-12 fori  
Boxes with 9-12 holes



Colore / Colour	H mm.	I* mm.	Codice / Code
Grigio / Gray	116	9	<b>SA 309 SL</b>
Grigio / Gray	116	12	<b>SA 312 SL</b>

Per le dimensioni vedi pagina 24-25 / For dimensions see page 24-25

Contenitori con 1 foro / Boxes with 1 hole

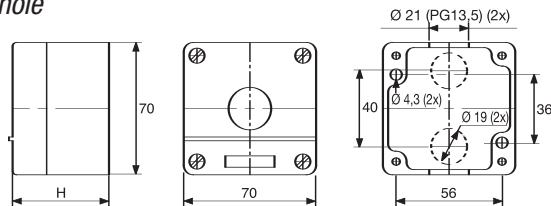

Contenitori con 2 fori / Boxes with 2 holes

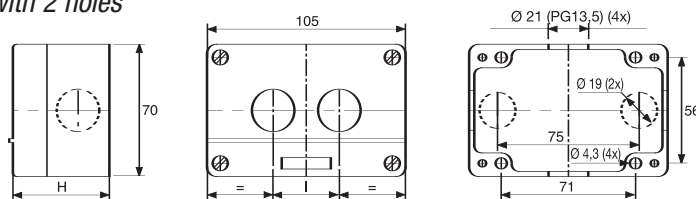

Contenitori con 3 fori / Boxes with 3 holes

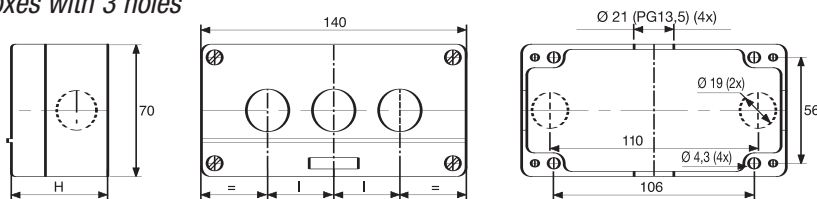

Contenitori con 4 fori / Boxes with 4 holes

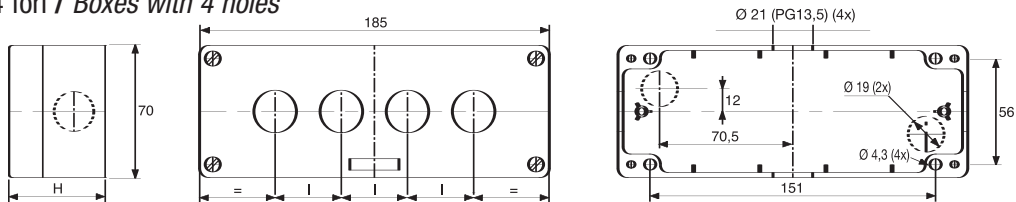

Contenitori con 5-6 fori / Boxes with 5-6 holes

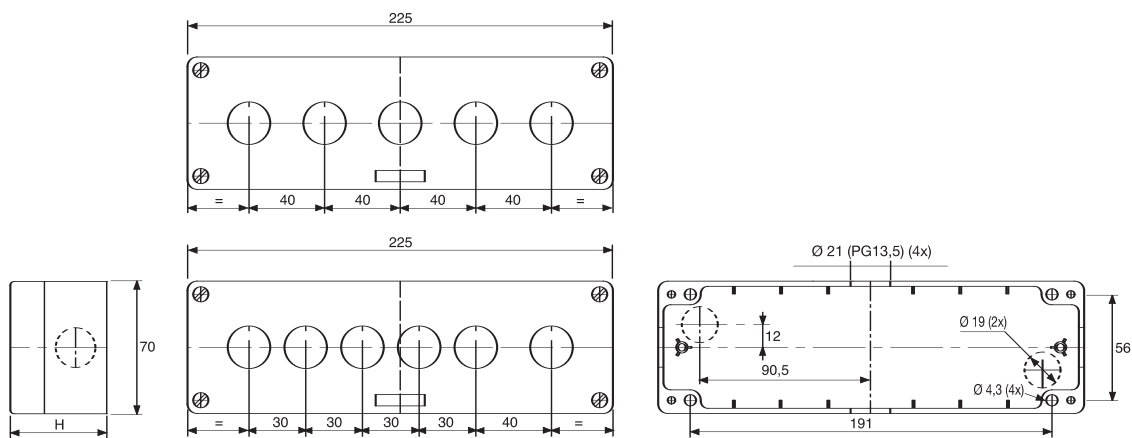

Contenitori con 6-7-8-9 fori  
Boxes with 6-7-8-9 holes

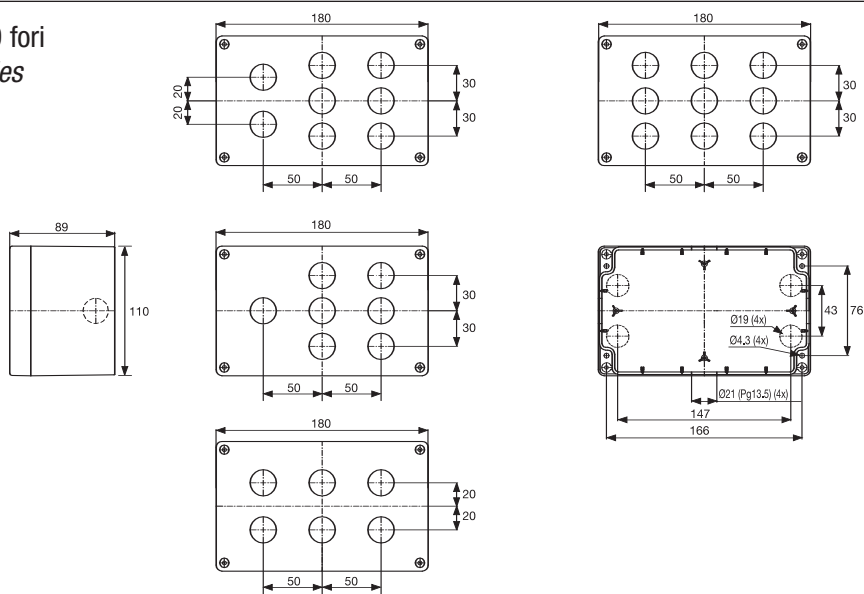

Contenitori con 9-12 fori /  
Boxes with 9-12 holes

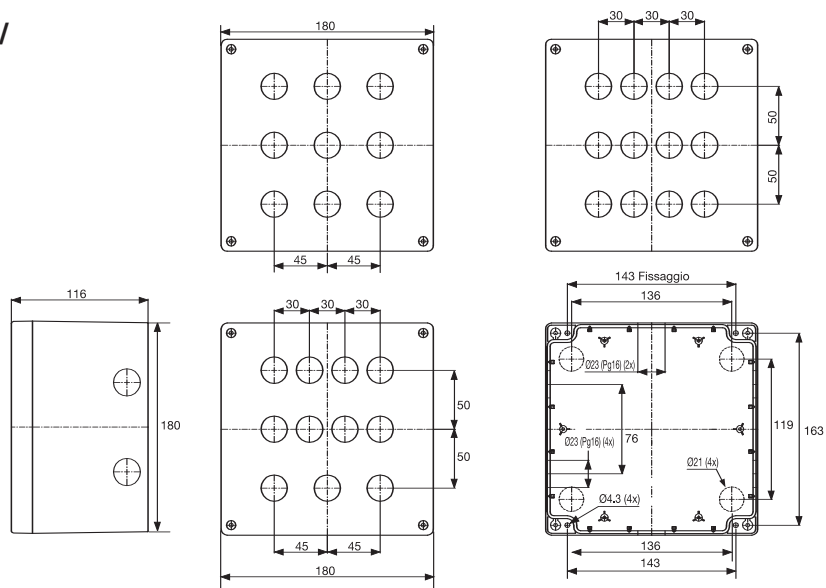



### Dati tecnici generali / General Technical Data

<b>Norme / Standards</b>		IEC 947-5-1 / EN 60947-5-1
<b>Temperatura ambiente/ Air temperature</b>		
– funzionamento / during operation	°C	– 25 ... + 70 °C
– stoccaggio / for storage	°C	– 40 ... + 80 °C
<b>Grado di protezione</b> (secondo IEC 529 ed EN 60529) <b>Degree of protection</b> (according to IEC 529 and EN 60529)		IP65 IP65
<b>Materiale</b> <b>Material</b>		Lega di alluminio AISi9Cu EN AB-47100 con Cu < 1% (ex UNI 5079) Aluminium alloy AISi9Cu EN-AB47100 with Cu < 1% (ex UNI 5079)
<b>Peso specifico / Specific weight</b>	Kg/dm <sup>3</sup>	2,65
<b>Carico di rottura / Ultimate tensile strenght</b>	Kg/mm <sup>2</sup>	23 ÷ 27
<b>Durezza Bainell / Bainell hardness</b>		75 ÷ 95
<b>Conduttività termica 20 °C / Heat conductivity at 20 °C</b>	cal/cm sec °C	0,37
<b>Resistenza al calore / Heat resistance</b>	°C	+300
<b>Resistenza al freddo / Cold resistance</b>	°C	–100
<b>Tipo di finitura / Kind of finishing</b>		
<b>A</b> = Scatola e coperchio sabbiati / Sandblasted box and cover		
<b>B</b> = Scatola e coperchio verniciati RAL 7035 / Painted box and cover RAL 7035 (Grey)		
<b>C</b> = Scatola sabbiata e coperchio verniciato giallo RAL 1023 / Sandblasted box and painted cover RAL 1023 (Yellow)		
<b>D</b> = Scatola verniciata grigio RAL 7035 - Coperchio verniciato giallo RAL 1023 / Painted box RAL 7035 (Grey) and painted cover RAL 1023 (Yellow)		

Per cassette assemblate con pulsanti contattare il nostro ufficio commerciale / Upon request, all the enclosures can be supplied complete with our ECX pushbutton series. Please contact our commercial department

Contenitori 90,5x90,5  
90,5x90,5 boxes

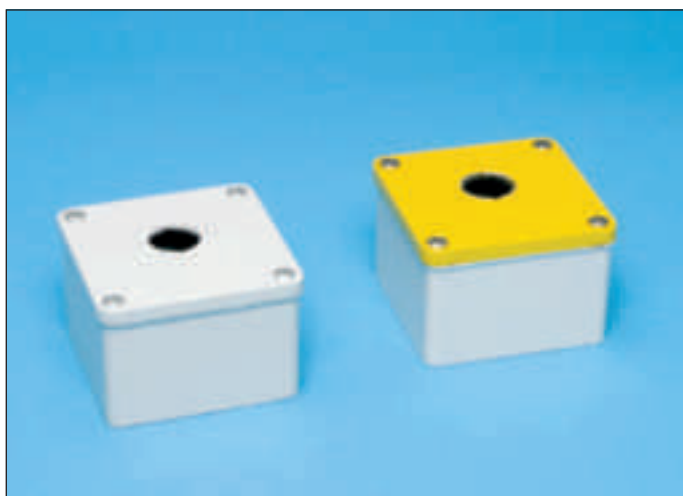

Dimensioni Dimensions	N° fori N° holes	Finitura Finishing	Codice Code
90,5x90,5x61	1	A	<b>SAM 100-A</b>
90,5x90,5x61	1	B	<b>SAM 100-B</b>
90,5x90,5x61	1	C	<b>SAM 100-C</b>
90,5x90,5x61	1	D	<b>SAM 100-D</b>
90,5x90,5x61	–	A	<b>SAM 200-A</b>
90,5x90,5x61	–	B	<b>SAM 200-B</b>

Per le dimensioni vedi pagina 27 / For dimensions see page 27

Contenitori 105,5x105,5  
105,5x105,5 boxes



Dimensioni Dimensions	N° fori N° holes	Finitura Finishing	Codice Code
105,5x105,5x81	1	A	<b>SAM 103-A</b>
105,5x105,5x81	1	B	<b>SAM 103-B</b>
105,5x105,5x81	1	C	<b>SAM 103-C</b>
105,5x105,5x81	1	D	<b>SAM 103-D</b>
105,5x105,5x81	2	A	<b>SAM 105-A</b>
105,5x105,5x81	2	B	<b>SAM 105-B</b>
105,5x105,5x81	–	A	<b>SAM 203-A</b>
105,5x105,5x81	–	B	<b>SAM 203-B</b>

Per le dimensioni vedi pagina 27 / For dimensions see page 27

Contenitori 125,5x78,5  
125,5x78,5 boxes



Dimensioni Dimensions	N° fori N° holes	Finitura Finishing	Codice Code
125,5x78,5x75	2	A	<b>SAM 106-A</b>
125,5x78,5x75	2	B	<b>SAM 106-B</b>
125,5x78,5x75	–	A	<b>SAM 206-A</b>
125,5x78,5x75	–	B	<b>SAM 206-B</b>

Per le dimensioni vedi pagina 27 / For dimensions see page 27

Contenitori 205,5x105,5  
205,5x105,5 boxes



Dimensioni Dimensions	N° fori N° holes	Finitura Finishing	Codice Code
205,5x105,5x81	3	A	<b>SAM 107-A</b>
205,5x105,5x81	3	B	<b>SAM 107-B</b>
205,5x105,5x81	6	A	<b>SAM 113-A</b>
205,5x105,5x81	6	B	<b>SAM 113-B</b>
205,5x105,5x81	–	A	<b>SAM 207-A</b>
205,5x105,5x81	–	B	<b>SAM 207-B</b>

Per le dimensioni vedi pagina 28 / For dimensions see page 28

Contenitori 255,5x90,5  
255,5x90,5 boxes



Dimensioni Dimensions	N° fori N° holes	Finitura Finishing	Codice Code
255,5x90,5x75	4	A	<b>SAM 109-A</b>
255,5x90,5x75	4	B	<b>SAM 109-B</b>
255,5x90,5x75	5	A	<b>SAM 111-A</b>
255,5x90,5x75	5	B	<b>SAM 111-B</b>
255,5x90,5x75	–	A	<b>SAM 209-A</b>
255,5x90,5x75	–	B	<b>SAM 209-B</b>

Per le dimensioni vedi pagina 28 / For dimensions see page 28

Contenitori 268x133  
268x133 boxes



Dimensioni Dimensions	N° fori N° holes	Finitura Finishing	Codice Code
268x133x91	8	A	<b>SAM 115-A</b>
268x133x91	8	B	<b>SAM 115-B</b>
268x133x91	12	A	<b>SAM 116-A</b>
268x133x91	12	B	<b>SAM 116-B</b>
268x133x91	–	A	<b>SAM 215-A</b>
268x133x91	–	B	<b>SAM 215-B</b>

Per le dimensioni vedi pagina 28 / For dimensions see page 28

Contenitori 90,5x90,5  
90,5x90,5 boxes

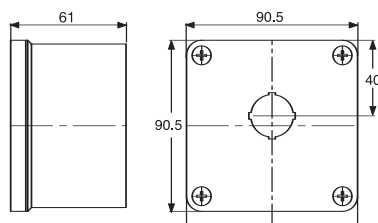

Contenitori 105,5x105,5  
105,5x105,5 boxes

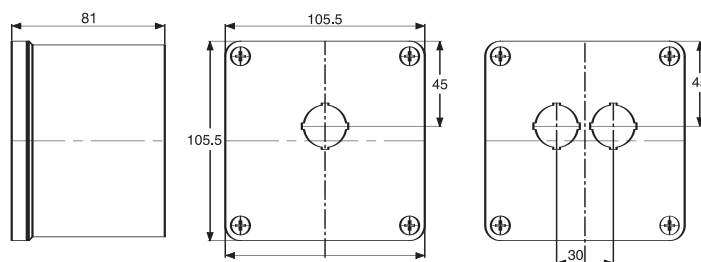

Contenitori 125,5x78,5  
125,5x78,5 boxes

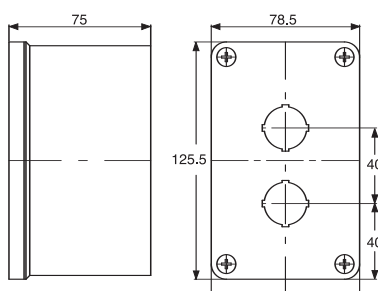

Contenitori 205,5x105,5  
205,5x105,5 boxes

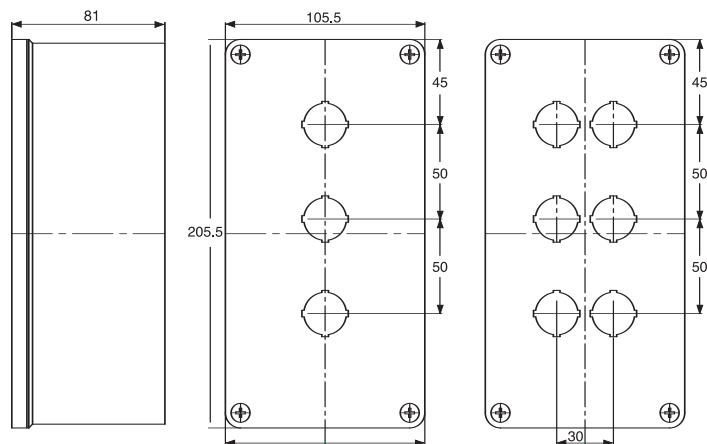

Contenitori 255,5x90,5  
255,5x90,5 boxes

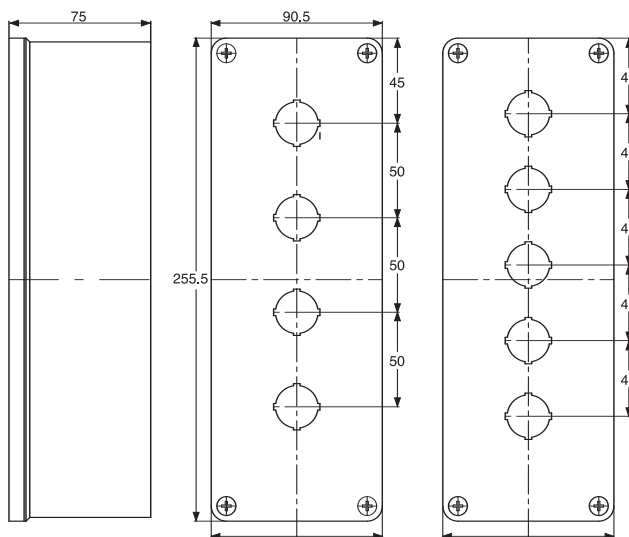

Contenitori 268x133  
268x133 boxes

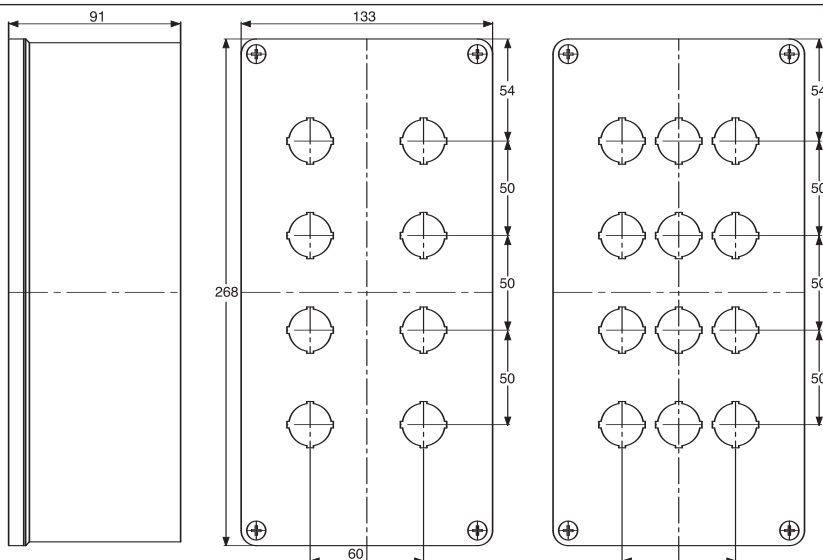

Contenitore con protezione per pulsante  
Enclosure with pushbutton protection



Dimensioni Dimensions	N° fori N° holes	Finitura Finishing	Codice Code
105,5x105,5x74	1	A	<b>SAM 120-A</b>
105,5x105,5x74	1	B	<b>SAM 120-B</b>
105,5x105,5x74	2	A	<b>SAM 121-A</b>
105,5x105,5x74	2	B	<b>SAM 121-B</b>

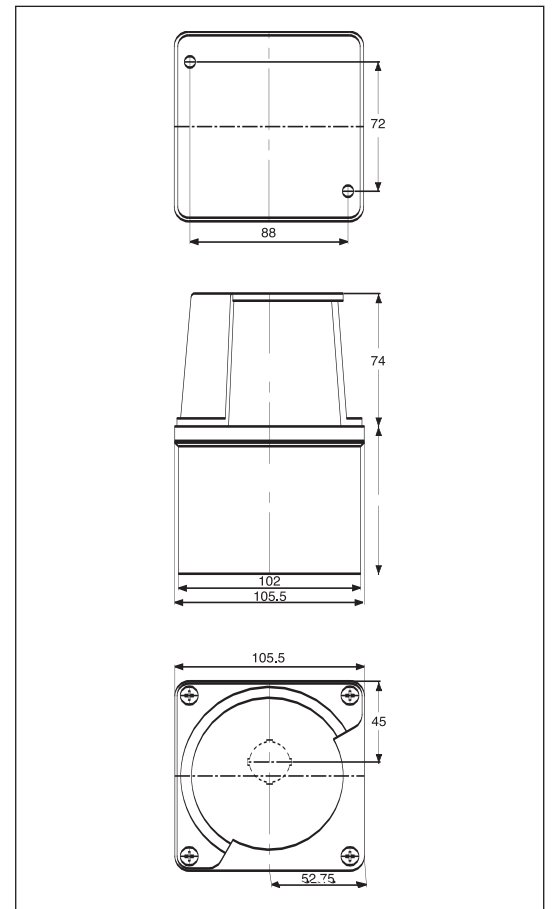

Contenitore per palo  
Pole enclosure



Codice tipo 1 Code type 1	Codice tipo 2 Code type 2	Codice tipo 3 Code type 3	N° fori N° holes	Finitura Finishing
<b>SAM 130-A</b>	<b>SAM 140-A</b>	<b>SAM 150-A</b>	1	A
<b>SAM 130-B</b>	<b>SAM 140-B</b>	<b>SAM 150-B</b>	1	B
<b>SAM 130-C</b>	<b>SAM 140-C</b>	<b>SAM 150-C</b>	1	C

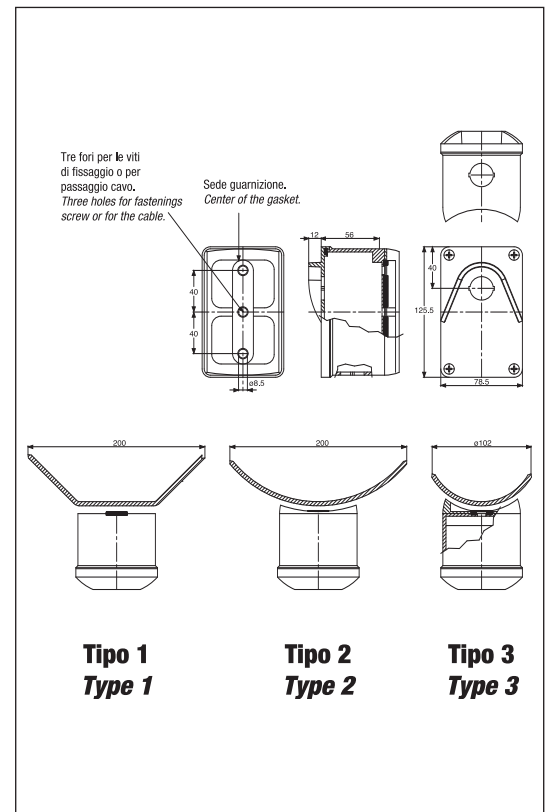



### Dati tecnici generali / General Technical Data

<b>Norme / Standards</b>		IEC 947-5-1 / EN 60947-5-1
<b>Temperatura ambiente/ Air temperature</b>		
– funzionamento / during operation	°C	– 25 ... + 70 °C
– stoccaggio / for storage	°C	–40 ... + 80 °C
<b>Grado di protezione</b> (secondo IEC 529 ed EN 60529) <b>Degree of protection</b> (according to IEC 529 and EN60529)		IP65 IP65
<b>Materiale corpo e coperchio / Casing and cover material</b>		AISI 304
<b>Forature con intagli antirotazione / Holes with antirotation incisions</b>	mm	ø 22,5
<b>Passo forature / Holes pitch</b>	mm	60x50

Per cassette assemblate con pulsanti contattare il nostro ufficio commerciale / Upon request, all the enclosures can be supplied complete with our ECX pushbutton series. Please contact our commercial department

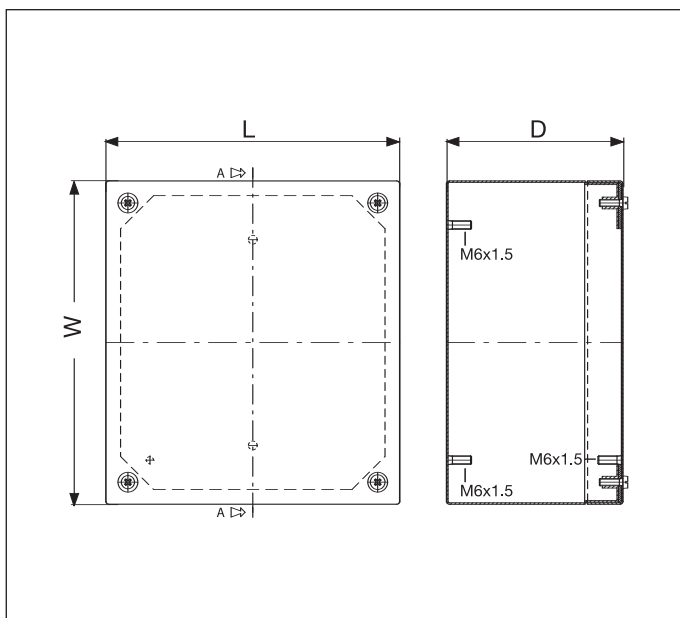

Dimensioni Dimensions			N° fori N° holes	Codice Code
L	W	D		
100	100	90	1	<b>SAX 10</b>
100	160	90	2	<b>SAX 20</b>
100	220	90	3	<b>SAX 30</b>
100	280	90	4	<b>SAX 40</b>
150	160	120	4	<b>SAX 41</b>
150	220	120	6	<b>SAX 60</b>
Kit fissaggio a parete / Wall implantation kit				<b>SAX 1000</b>

Contenitori con misure diverse e con più fori disponibili a richiesta.  
Enclosures with different dimensions and more holes available upon request.